

1.Remove the side panel

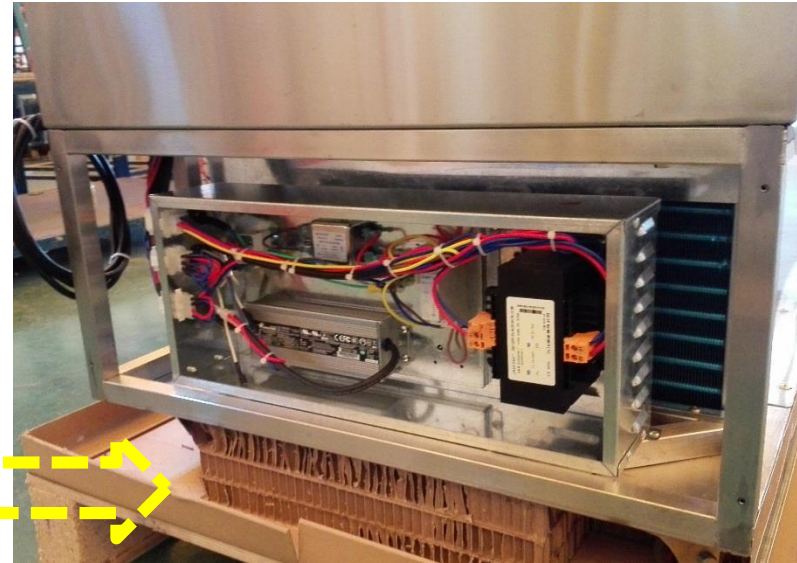

2. Remove the transformer

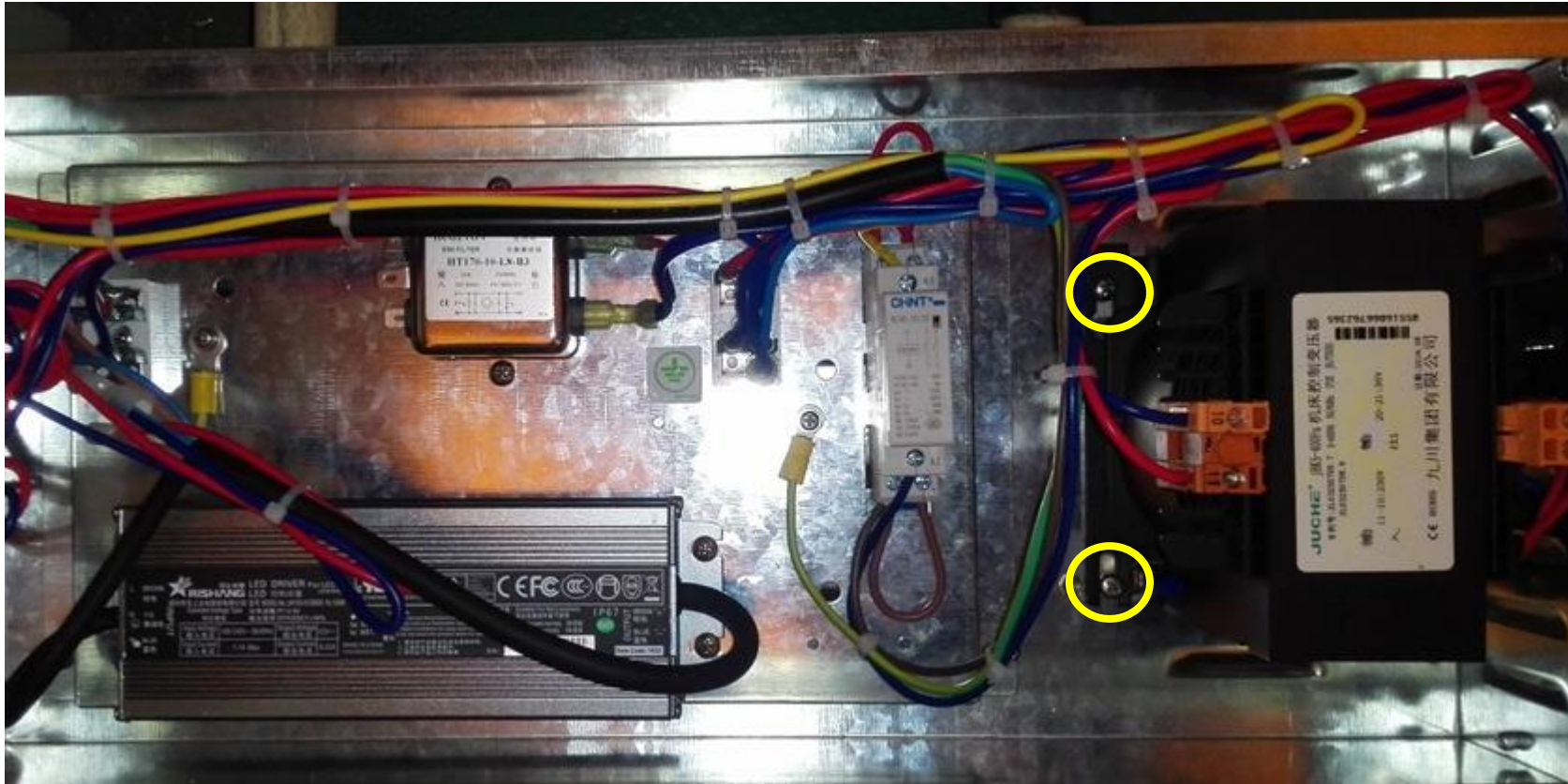

- a. Remove the transformer terminals.
- b. Unscrew 4 pcs screws and move out the transformer.

3. Transformer assembly

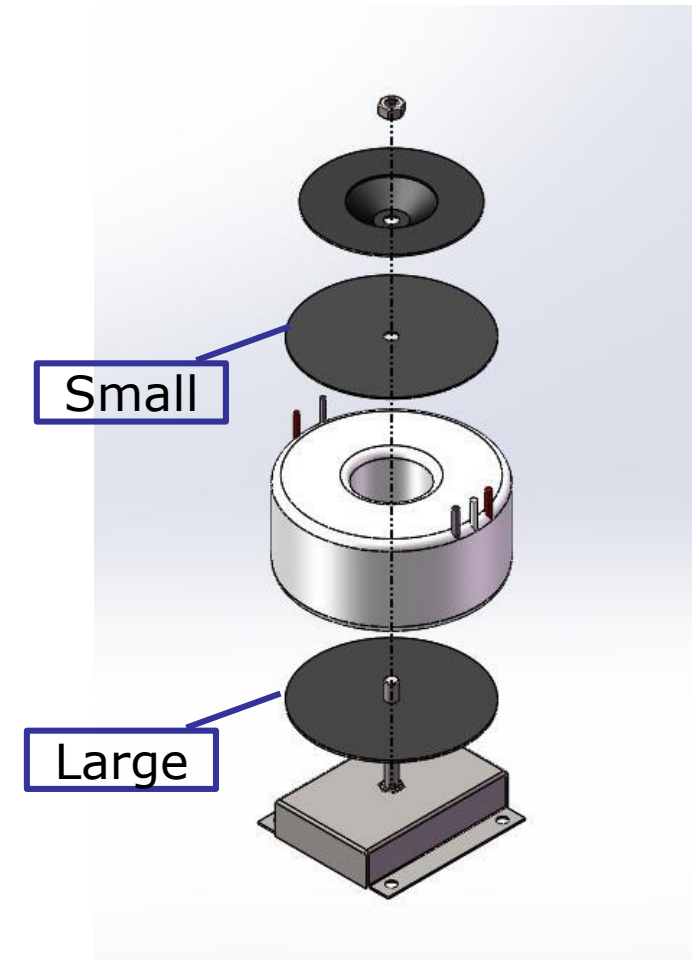

- Bolt the bolt through the S/S holder.
- The large washer was at the bottom of transformer and the small washer was at the top.
- Then cover the black panel and screw the nut and washer.

4. Transformer wiring

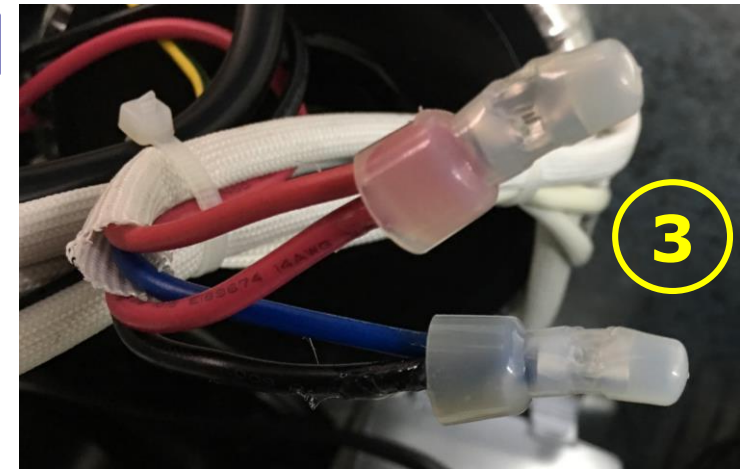
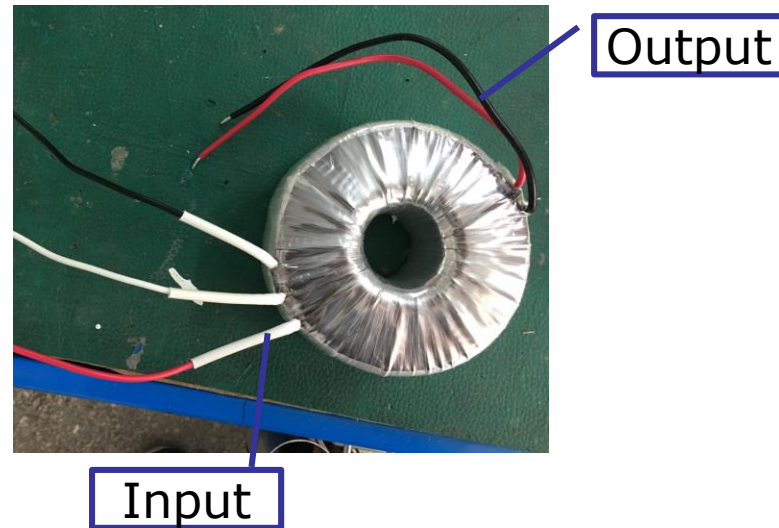
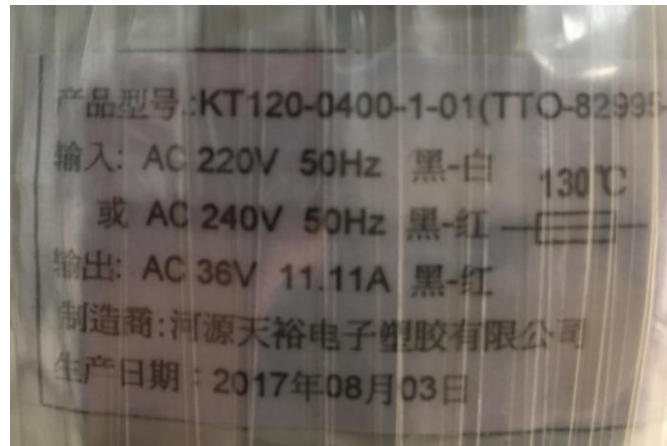

- Input were connect the red and black wires. White wire was only for 220 voltage.
- "Black" & "Blue" wires connect and crimping as pic 3. "Red" & "Red" wires crimping.
- Make sure the input and output wiring was correct.

5. Install the transformer

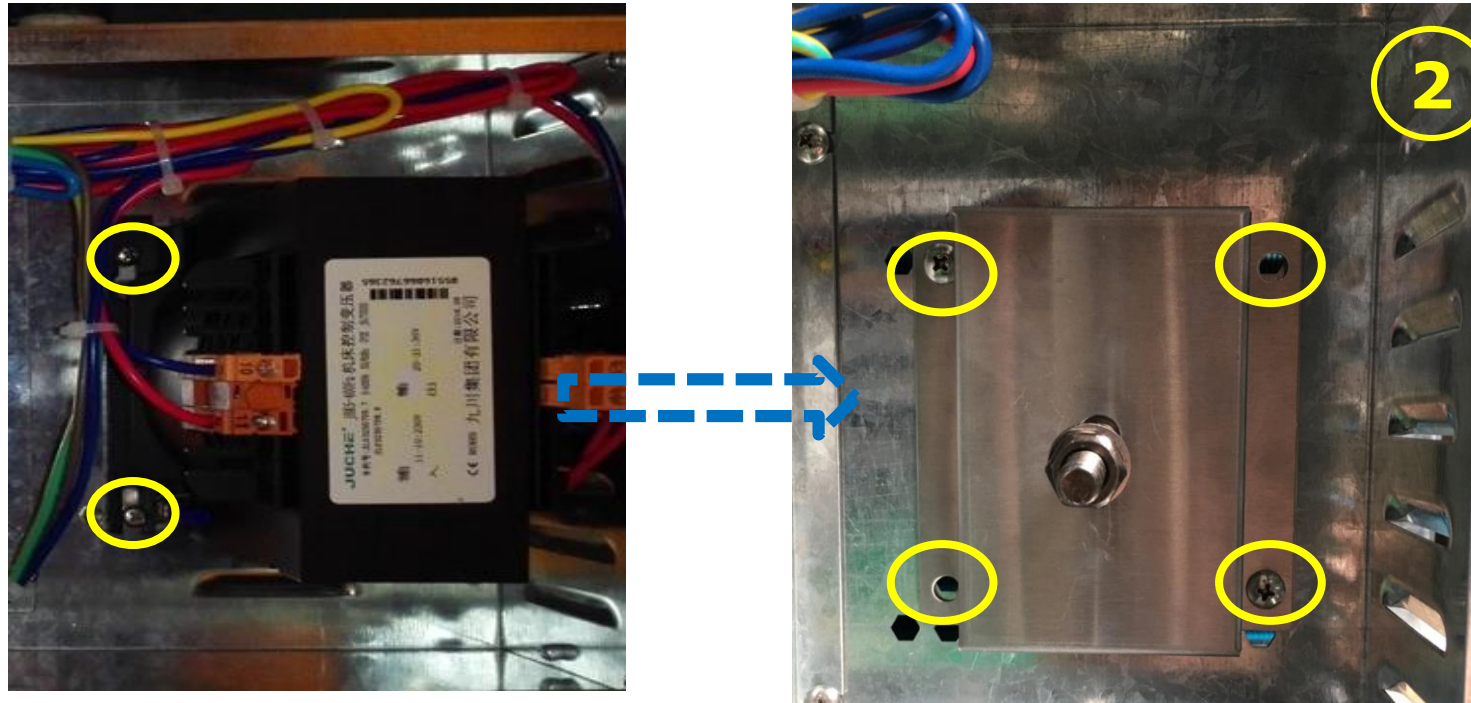

- a. Install the whole assembly part on the controller box and lock 4 pcs screws. As pic 2**