



### PRODUCT FEATURES

- Open front
- Stainless steel hinged rear door
- Deck forced refrigeration
- Double glazed glass ends
- Two adjustable glass shelves
- Ticket strips on shelves and base
- Under shelf and canopy LED lights
- Pull down night blind
- Integral condenser
- Pigeonhole perspex screens

### CABINET DIMENSIONS & SPECIFICATIONS

Refrigerated 4<sup>0</sup> factory set point

Model	Cabinet			Shelving no.	SHELVES SIZE				Total food units	Display m2
	Length mm	Depth mm	Height mm		TOP	2ND	3RD	BASE(WXD)		
BTGOR6	600	750	1380	2+BASE	490X290	490X380	NA	545X515	55	0.60

Prior to installation see, installation guidelines, ventilation requirements and drainage options documents

Refrigerant	Operating Current	Connection	Voltage
R134A	3.3 Amp	10amp 3 pin plug	50/60 Hertz 240V

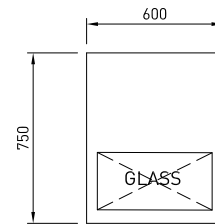

### ELECTRICAL POWER

Electrical power cord 2200mm  
3 pin 10 amp 1 phase socket required  
Maximum ambient operating temperature 25°C @ RH 55

Maximum shelf load weight 15kg spread evenly

All units rear venting

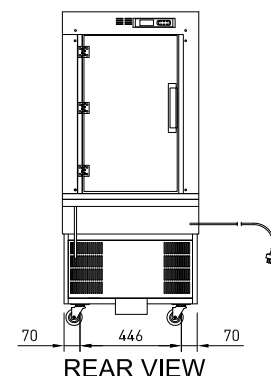
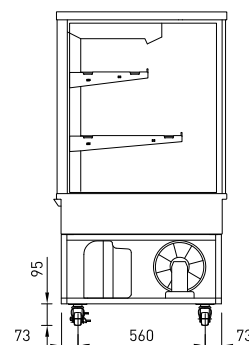
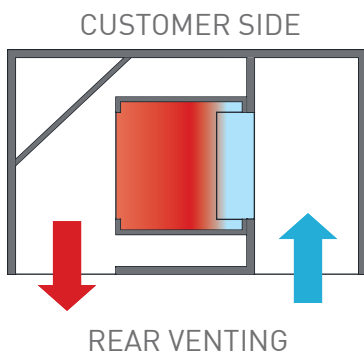
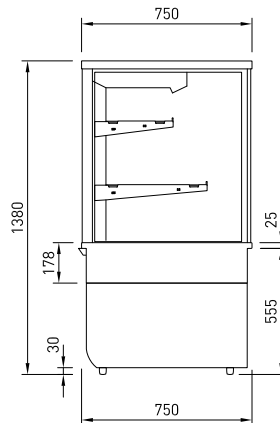



### PRODUCT FEATURES

- Open front
- Stainless steel hinged rear doors
- Deck forced refrigeration
- Double glazed glass ends
- Two adjustable glass shelves
- Ticket strips on shelves and base
- Under shelf and canopy LED lights
- Pull down night blind
- Integral condenser
- Pigeonhole perspex screens

### CABINET DIMENSIONS & SPECIFICATIONS

Refrigerated 4<sup>0</sup> factory set point

Model	Cabinet			Shelving no.	SHELVES SIZE				Total food units	Display m2
	Length mm	Depth mm	Height mm		TOP	2ND	3RD	BASE(WXD)		
BTGOR9	900	750	1380	2+BASE	790X290	790X380	NA	845X515	114	0.96

Prior to installation see, installation guidelines, ventilation requirements and drainage options documents

Refrigerant	Operating Current	Connection	Voltage
R134A	3.7 Amp	10amp 3 pin plug	50/60 Hertz 240V

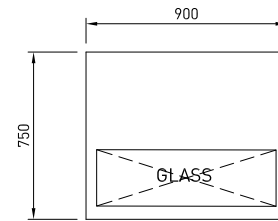

### ELECTRICAL POWER

Electrical power cord 2200mm  
3 pin 10 amp 1 phase socket required  
Maximum ambient operating temperature 25°C @ RH 55

Maximum shelf load weight 15kg spread evenly

All units rear venting

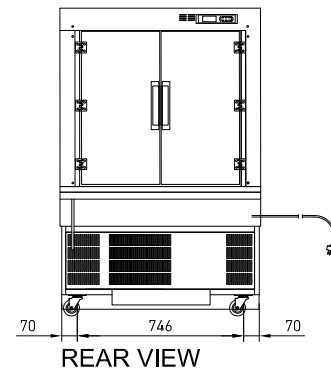
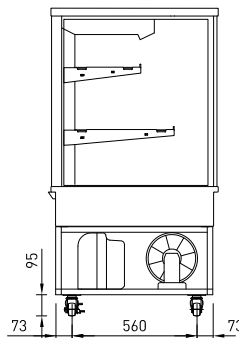
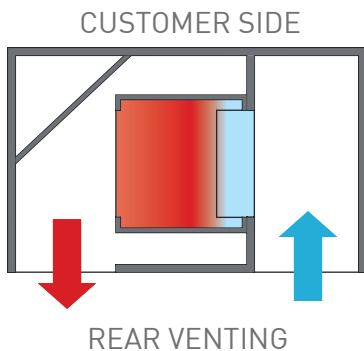
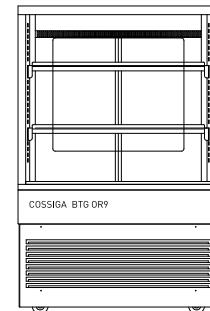
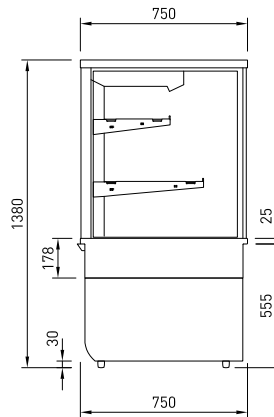



## PRODUCT FEATURES

- Open front
- Stainless steel hinged rear doors
- Deck forced refrigeration
- Double glazed glass ends
- Two adjustable glass shelves
- Ticket strips on shelves and base
- Under shelf and canopy LED lights
- Pull down night blind
- Integral condenser
- Pigeonhole perspex screens

## CABINET DIMENSIONS & SPECIFICATIONS

Refrigerated 4<sup>0</sup> factory set point

Model	Cabinet			Shelving no.	SHELVES SIZE				Total food units	Display m2
	Length mm	Depth mm	Height mm		TOP	2ND	3RD	BASE(WXD)		
BTGOR12	1200	750	1380	2+BASE	1090 X 290	1090 X 380	NA	1145 X 515	123	1.31

Prior to installation see, installation guidelines, ventilation requirements and drainage options documents

Refrigerant	Operating Current	Connection	Voltage
R134A	5.4 Amp	10amp 3 pin plug	50/60 Hertz 240V

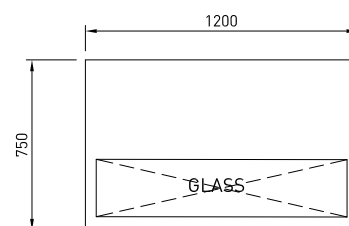

## ELECTRICAL POWER

Electrical power cord 2200mm  
3 pin 10 amp 1 phase socket required  
Maximum ambient operating temperature 25°C @ RH 55

Maximum shelf load weight 15kg  
spread evenly

All units rear venting

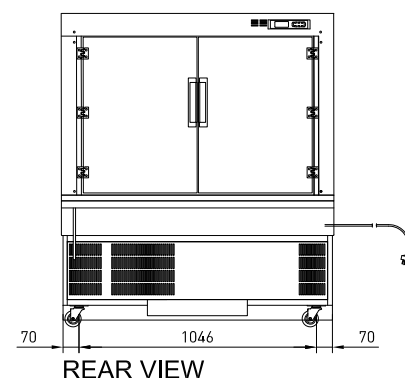
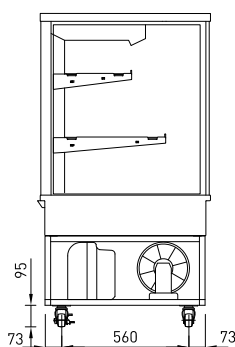
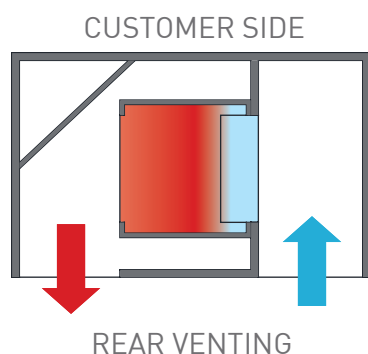
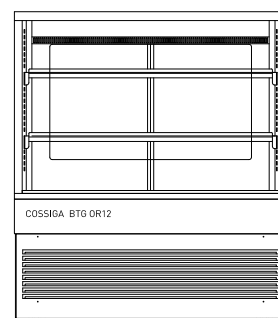
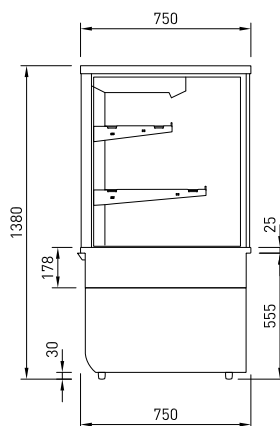



## PRODUCT FEATURES

- Open front
- Stainless steel hinged rear doors
- Deck forced refrigeration
- Double glazed glass ends
- Two adjustable glass shelves
- Ticket strips on shelves and base
- Under shelf and canopy LED lights
- Pull down night blind
- Integral condenser
- Pigeonhole perspex screens

## CABINET DIMENSIONS & SPECIFICATIONS

Refrigerated 4<sup>0</sup> factory set point

Model	Cabinet			Shelving no.	SHELVES SIZE				Total food units	Display m2
	Length mm	Depth mm	Height mm		TOP	2ND	3RD	BASE(WXD)		
BTGOR15	1500	750	1380	2+BASE	1390X290	1390X380	NA	1445 X 515	168	1.67

Prior to installation see, installation guidelines, ventilation requirements and drainage options documents

Refrigerant	Operating Current	Connection	Voltage
R134A	6.5 Amp	10amp 3 pin plug	50/60 Hertz 240V

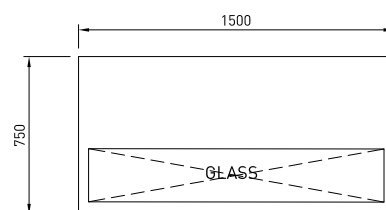

## ELECTRICAL POWER

Electrical power cord 2200mm  
3 pin 10 amp 1 phase socket required  
Maximum ambient operating temperature 25°C @ RH 55

Maximum shelf load weight 15kg  
spread evenly

All units rear venting

