

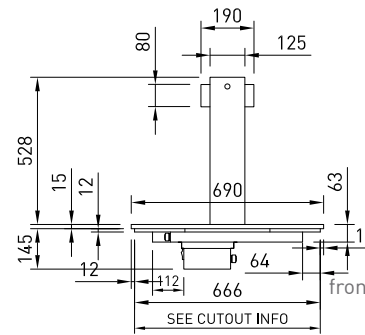

CM

LSCM2
LSCM3
LSCM4
LSCM5
LSCM6

- Ceramic Heated Glass
- Overhead Halogen Lamps
- Digital thermostatic controller
- Heat indicating LED lights



LEFT SIDE

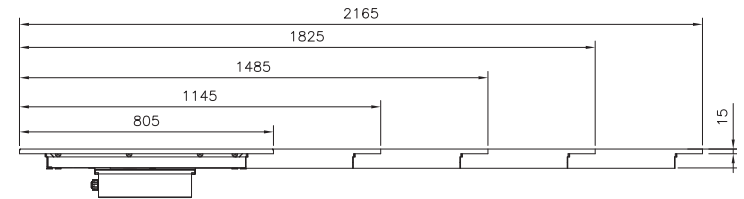
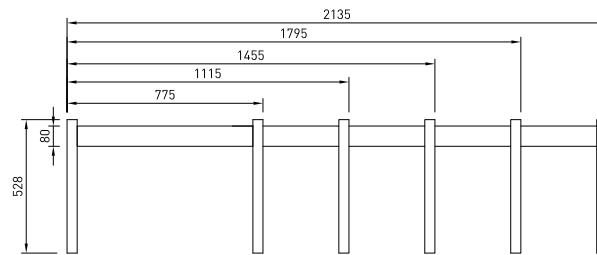
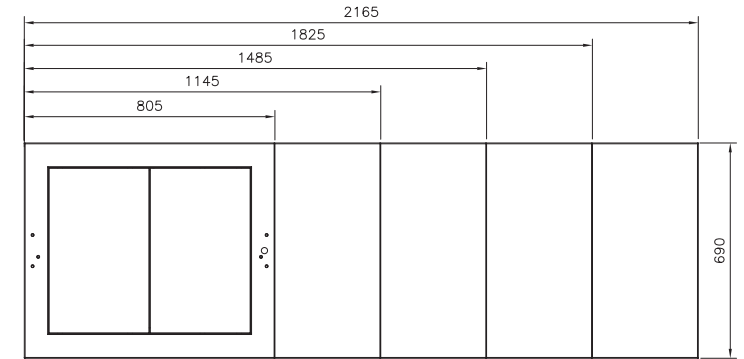

GANTRY SIZES

CABINET DIMENSIONS & SPECIFICATIONS

MODEL	CABINET			BENCH TOP CUT OUT HOLE SIZE	PANS	TEMP RANGE	POWER CORD LENGTH	FREQUENCY	OPERATING CURRENT WITH LAMPS	OPERATING CURRENT NO GANTRY	CONNECTION	VOLTAGE	PACKED FOR SHIPPING				
	LENGTH [MM]	DEPTH [MM]	HEIGHT [MM]										LENGTH [MM]	DEPTH [MM]	HEIGHT [MM]	WEIGHT [KG]	CUBE
LSCM2	805	690	555	775x672	N/A	100-115	3000MM	50/60 HZ	7.5 AMP	5.0 AMP	15 AMP LEAD ONLY	220-240V	910	770	410	76	0.3504
LSCM3	1145	690	555	1115x672	N/A	100-115	3000MM	50/60 HZ	11.3 AMP	7.5 AMP	15 AMP LEAD ONLY	220-240V	1250	770	410	88	0.4813
LSCM4	1485	690	555	1455x672	N/A	100-115	3000MM	50/60 HZ	15 AMP	10.0 AMP	20 AMP LEAD ONLY	220-240V	1590	770	410	107	0.6122
LSCM5	1825	690	555	1795x672	N/A	100-115	3000MM	50/60 HZ	18.8 AMP	12.5 AMP	20 AMP LEAD ONLY	220-240V	1930	770	410	128	0.7431
LSCM6	2165	690	555	2135x672	N/A	100-115	3000MM	50/60 HZ	22.5 AMP	15.0AMP	30 AMP LEAD ONLY	220-240V	2270	770	410	140	0.8740



CM LSSC1

- Single ceramic heated glass
- Digital thermostatic controller
- Heat indicating LED lights on panel
- Flush mount drop in module

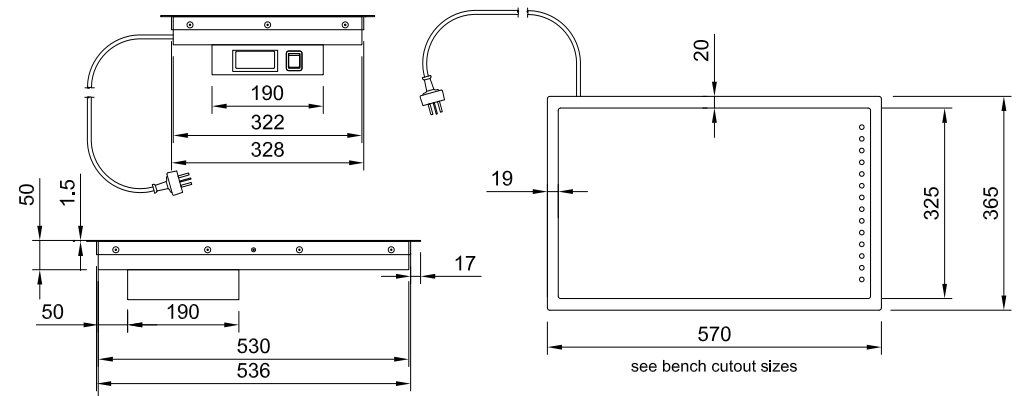



GLFT Flat Top

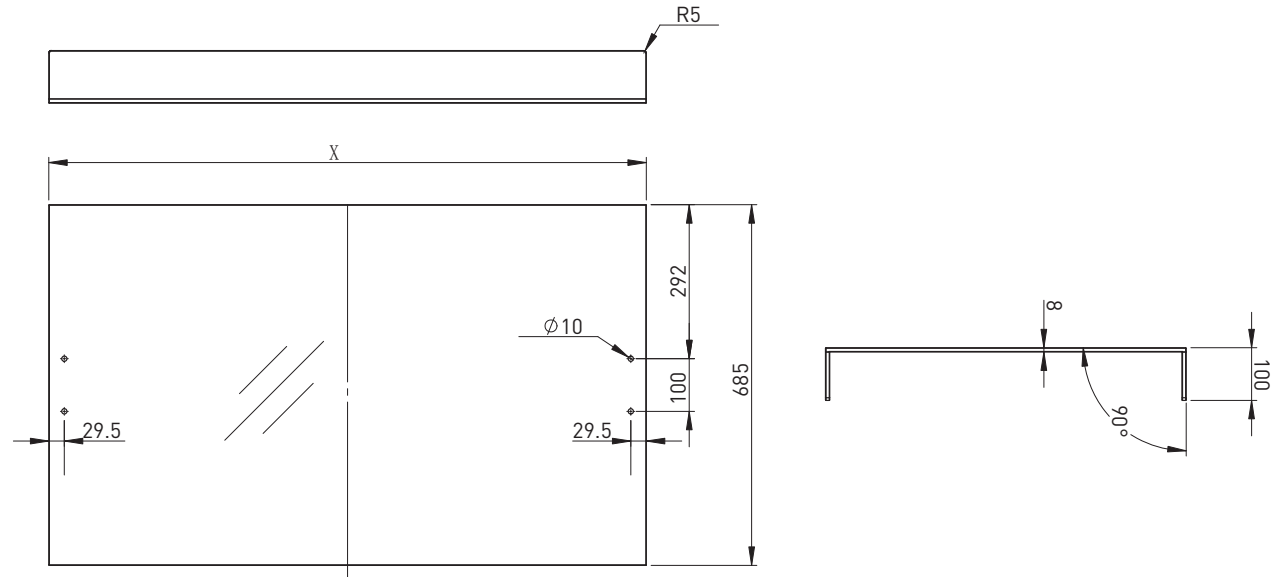

GLFS Full Square Glass

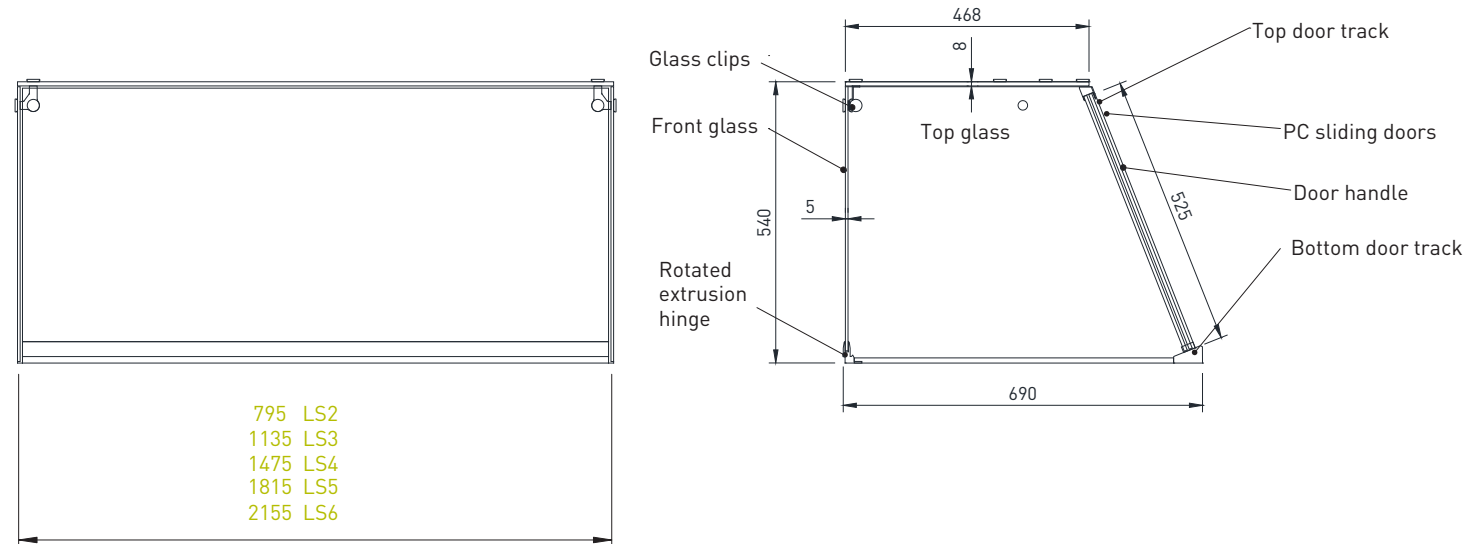

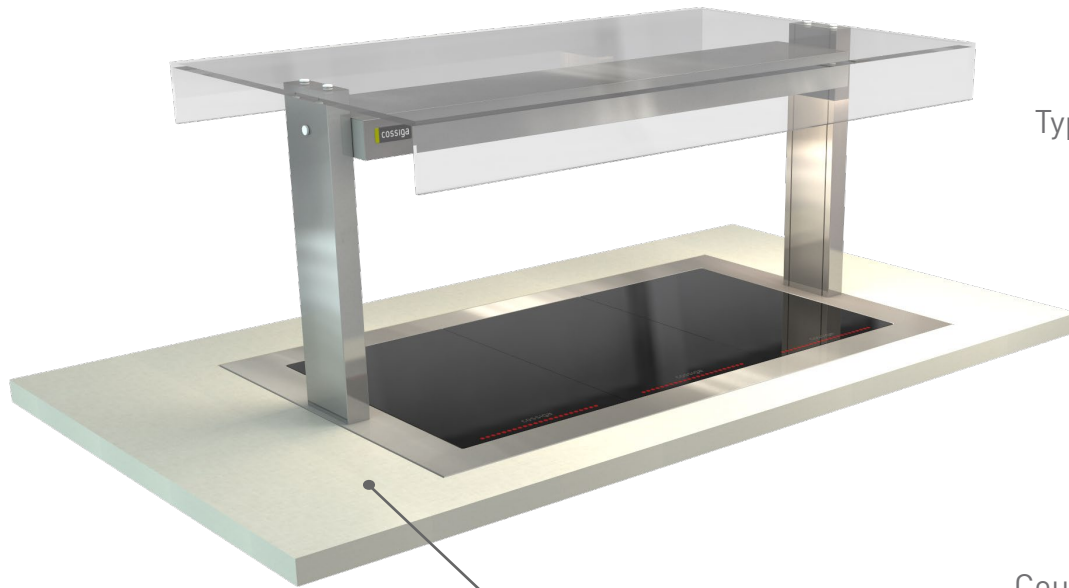

Additional support may be required under bench ie. stainless steel hollow section to frame

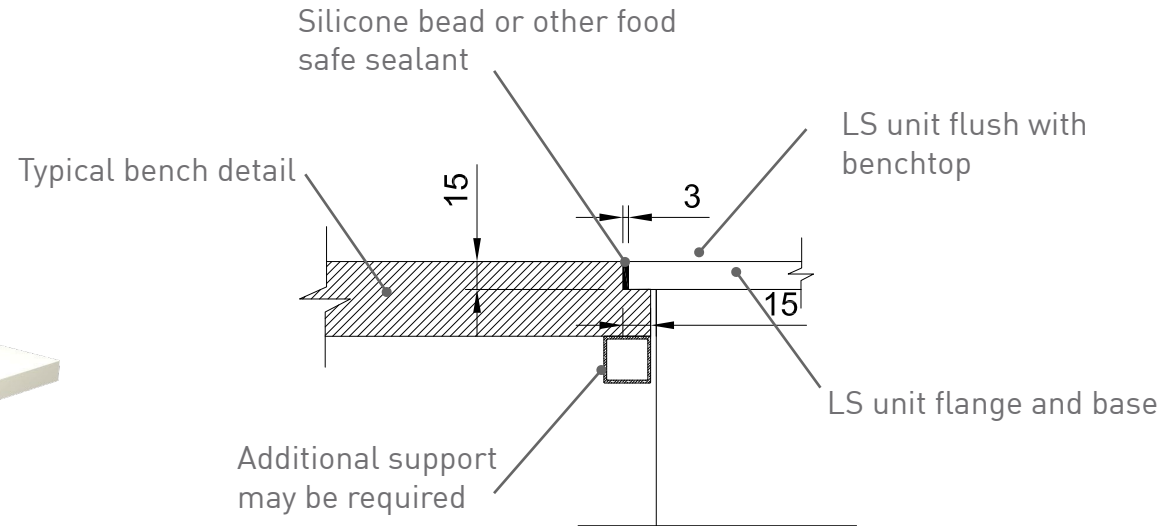

Counter top joinery must be of sufficient structural capacity to take the weight of the LS unit when the flange detail has been made.

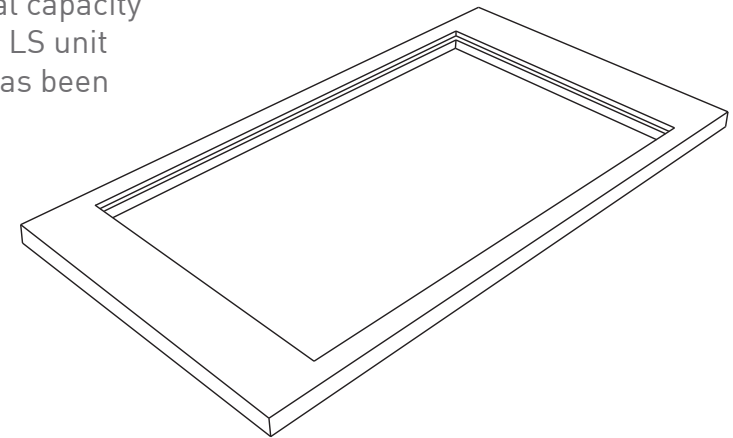

ELECTRICAL POWER

Electrical power cord 3000mm
1 phase connection required.

Unit can be hard wired to isolation switch or fitted with suitable heavy duty plug such as PDL 56 series or Commando style plug.

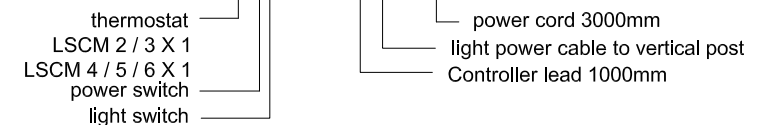
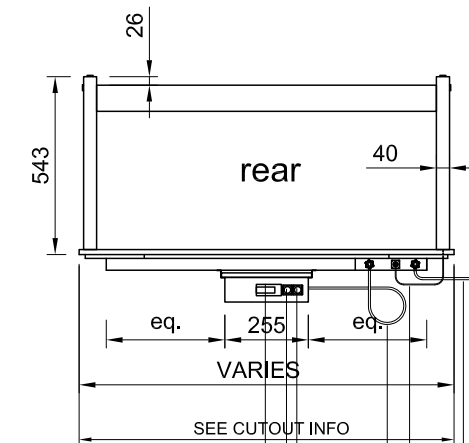
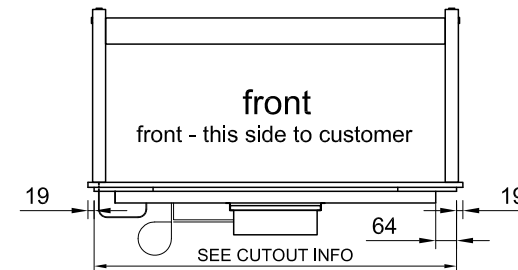
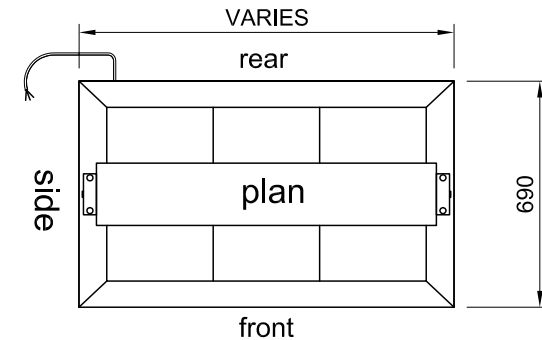
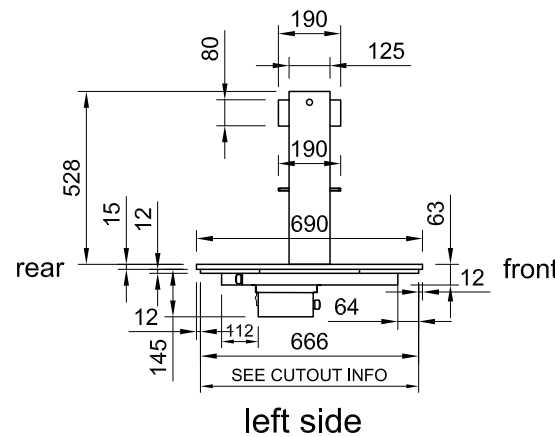

Panel
Controllers
LSCM 2/3 X1
LSCM 4/5/6 X 2

PANEL CONTROLLERS

MODEL	NUMBER OF PANELS	NUMBER OF CONTROLLERS	GROUP OF PANELS CONTROLLED
LSCM2	2	1	CONTROLLER 1 - 2
LSCM3	3	1	CONTROLLER 1 - 3
LSCM4	4	2	CONTROLLER 1 - 2 CONTROLLER 2 - 2
LSCM5	5	2	CONTROLLER 1 - 2 CONTROLLER 2 - 3
LSCM6	6	2	CONTROLLER 1 - 3 CONTROLLER 2 - 3

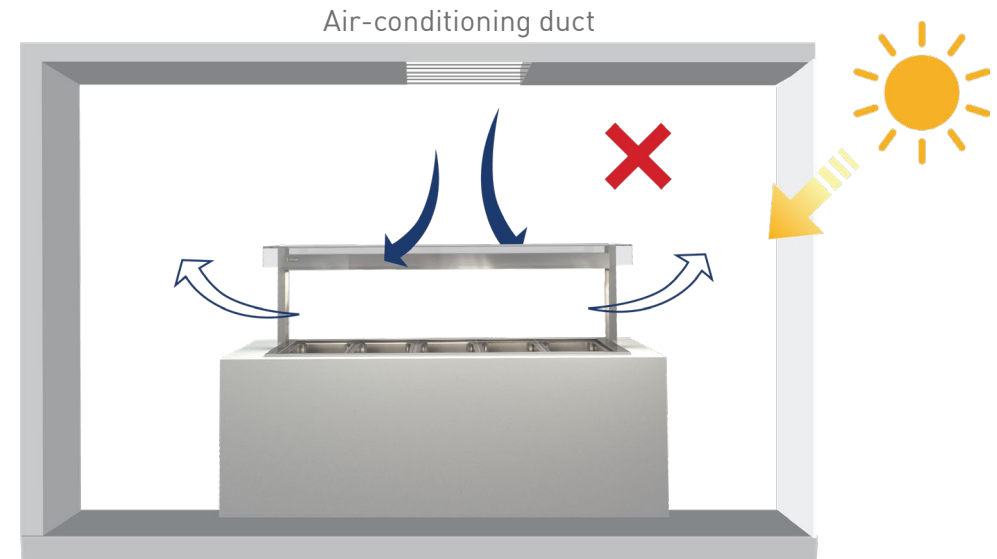
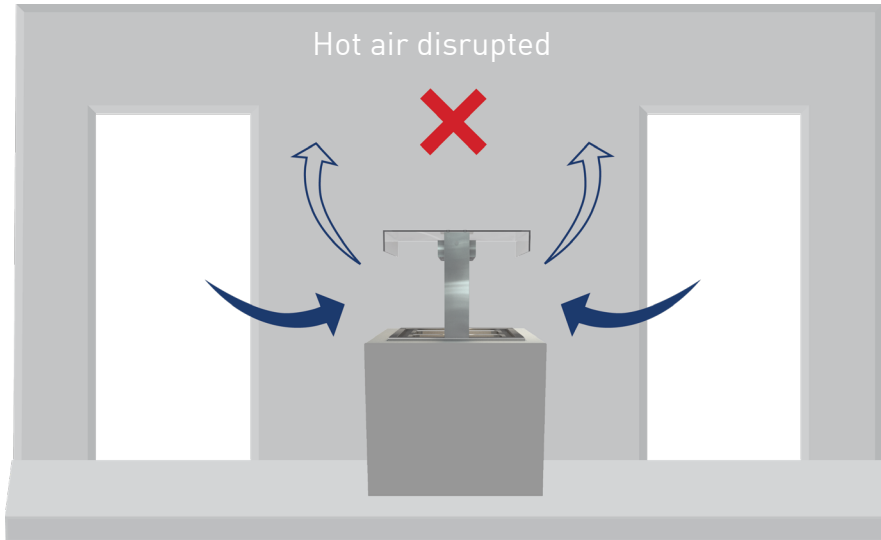

Locations to avoid

- Drafts from doorways
- Airflow from air-conditioning ducts
- Hot air from motors i.e. refrigerators
- Direct sunlight

Disrupted air flow

Heat from other equipment and natural conditions, such as direct sunlight straight on units, can cause cooling to fail and overload compressor

Mechanical air flows, such as diffusers and fans can disturb the air curtain on units causing failure