



### PRODUCT FEATURES

- Open front 1500mm high
- Stainless steel hinged rear door
- Deck forced refrigeration
- Double glazed glass ends
- Three adjustable glass shelves
- Ticket strips on shelves and base
- Under shelf and canopy LED lights
- Pull down night blind

### CABINET DIMENSIONS & SPECIFICATIONS

Refrigerated 4<sup>0</sup> factory set point

Model	Cabinet			Shelving no.	SHELVES SIZE				Total food units	Display m2
	Length mm	Depth mm	Height mm		TOP	2ND	3RD	BASE(WXD)		
TTGOR6	600	750	1500	3+BASE	490X295	490X325	490X415	545X515	75	.78

Prior to installation see, installation guidelines, ventilation requirements and drainage options documents

Refrigerant	Operating Current	Connection	Voltage
R134A	3.3 Amp	10amp 3 pin plug	50/60 Hertz 240V

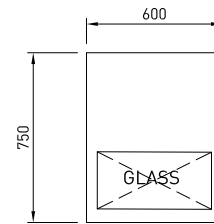

### ELECTRICAL POWER

Electrical power cord 2200mm  
3 pin 10 amp 1 phase socket required  
Maximum ambient operating temperature 25°C @ RH 55

Maximum shelf load weight 15kg  
spread evenly

All units rear venting

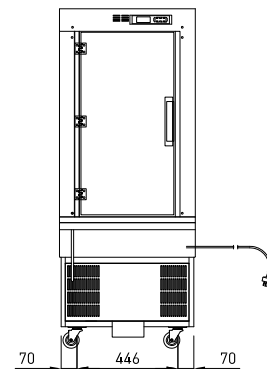
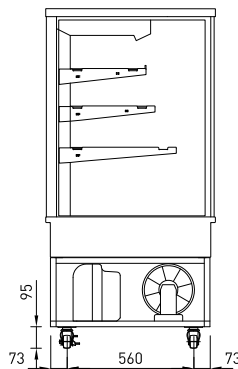
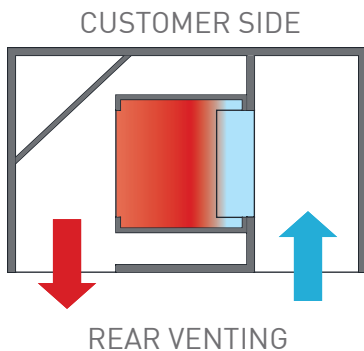
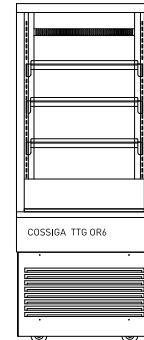
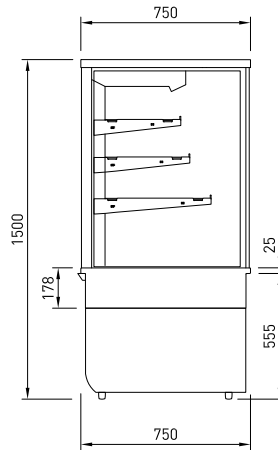



### PRODUCT FEATURES

- Open front 1500mm high
- Stainless steel hinged rear doors
- Deck forced refrigeration
- Double glazed glass ends
- Three adjustable glass shelves
- Ticket strips on shelves and base
- Under shelf and canopy LED lights
- Pull down night blind
- Integral condenser

### CABINET DIMENSIONS & SPECIFICATIONS

Refrigerated 4<sup>0</sup> factory set point

Model	Cabinet			Shelving no.	SHELVES SIZE				Total food units	Display m2
	Length mm	Depth mm	Height mm		TOP	2ND	3RD	BASE(WXD)		
TTGOR9	900	750	1500	3+BASE	790X295	790X325	790X415	845X515	120	1.25

Prior to installation see, installation guidelines, ventilation requirements and drainage options documents

Refrigerant	Operating Current	Connection	Voltage
R134A	3.7 Amp	10amp 3 pin plug	50/60 Hertz 240V

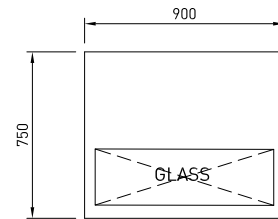

### ELECTRICAL POWER

Electrical power cord 2200mm  
3 pin 10 amp 1 phase socket required  
Maximum ambient operating temperature 25°C @ RH 55

Maximum shelf load weight 15kg spread evenly

All units rear venting

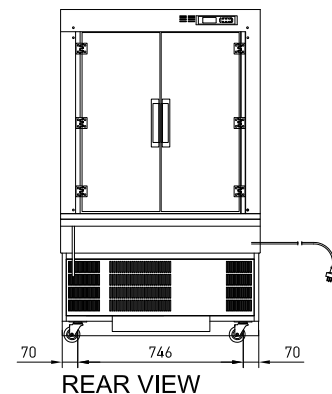
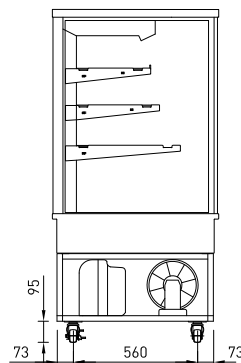
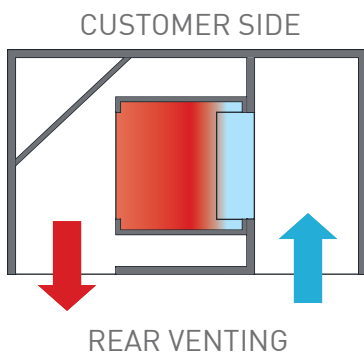
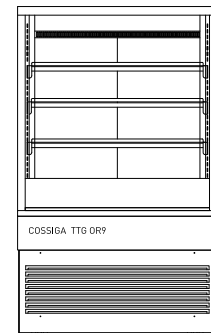
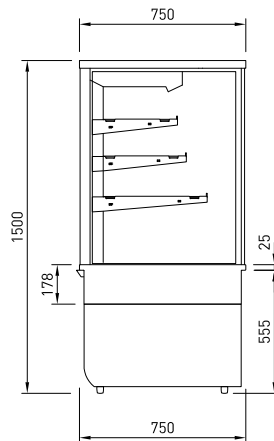



## PRODUCT FEATURES

- Open front 1500mm high
- Stainless steel hinged rear doors
- Deck forced refrigeration
- Double glazed glass ends
- Three adjustable glass shelves
- Ticket strips on shelves and base
- Under shelf and canopy LED lights
- Pull down night blind
- Integral condenser

## CABINET DIMENSIONS & SPECIFICATIONS

Refrigerated 4<sup>0</sup> factory set point

Model	Cabinet			Shelving no.	SHELVES SIZE				Total food units	Display m2
	Length mm	Depth mm	Height mm		TOP	2ND	3RD	BASE(WXD)		
TTGOR12	1200	750	1500	3+BASE	1090X295	1090X325	1090X415	1145X515	155	1.71

Prior to installation see, installation guidelines, ventilation requirements and drainage options documents

Refrigerant	Operating Current	Connection	Voltage
R134A	5.4 Amp	10amp 3 pin plug	50/60 Hertz 240V

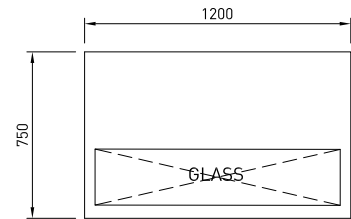

## ELECTRICAL POWER

Electrical power cord 2200mm  
3 pin 10 amp 1 phase socket required  
Maximum ambient operating temperature 25°C @ RH 55

Maximum shelf load weight 15kg  
spread evenly

All units rear venting

