



PRODUCT FEATURES

- Open front
- Individual shelf heating
- Deck forced heating
- Single glazed
- Hinged rear door
- Ticket strips on shelves and base
- Under shelf and canopy LED lights

CABINET DIMENSIONS & SPECIFICATIONS

Heated 75° factory set point

Model	Cabinet			Shelving no.	SHELVES SIZE				Total food units	Display m2
	Length mm	Depth mm	Height mm		TOP	2ND	3RD	BASE(WXD)		
BTGOH6	600	750	1380	3+BASE	490X255	490X335	490X415	548X595	50	

Prior to installation see, installation guidelines, ventilation requirements and drainage options documents

Operating Current	Connection	Voltage
8.1 Amp	10amp 3 pin plug	50/60 Hertz 240V

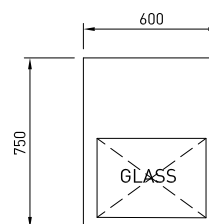

ELECTRICAL POWER

Electrical power cord 2200mm
3 pin 10 amp 1 phase socket required.

Maximum shelf load weight 15kg
spread evenly

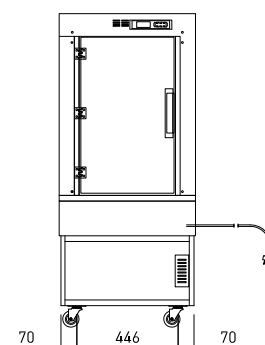
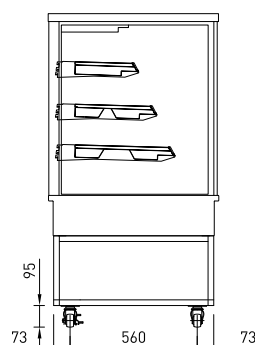
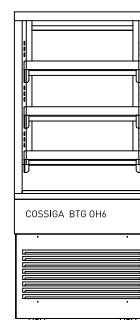
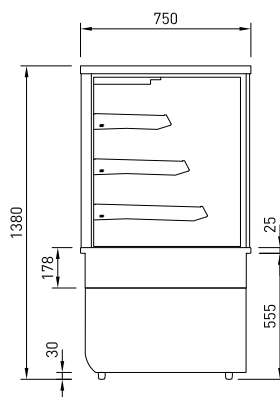

REAR VIEW



PRODUCT FEATURES

- Open front
- Individual shelf heating
- Deck forced heating
- Single glazed
- Sliding rear doors
- Ticket strips on shelves and base
- Under shelf and canopy LED lights

CABINET DIMENSIONS & SPECIFICATIONS

Heated 75° factory set point

Model	Cabinet			Shelving no.	SHELVES SIZE				Total food units	Display m2
	Length mm	Depth mm	Height mm		TOP	2ND	3RD	BASE(WXD)		
BTGOH9	900	750	1380	3+BASE	790X255	790X335	790X415	848X595	96	

Prior to installation see, installation guidelines, ventilation requirements and drainage options documents

Operating Current	Connection	Voltage
		50/60 Hertz
12.6 Amp	15amp 3 pin plug	240V

ELECTRICAL POWER

Electrical power cord 2200mm
3 pin 15 amp 1 phase socket required.

Maximum shelf load weight 15kg
spread evenly

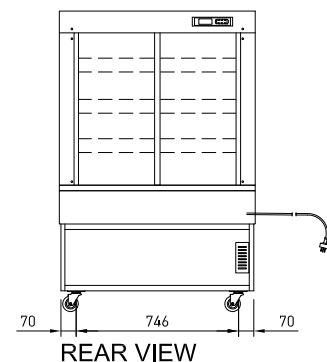
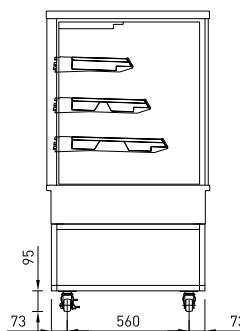
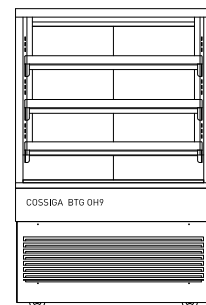
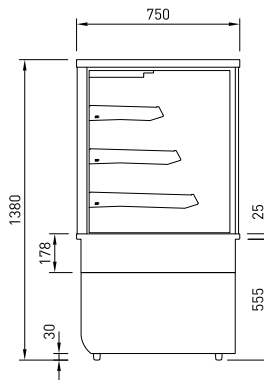
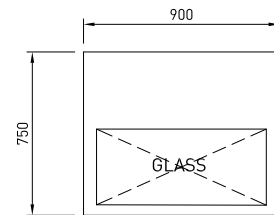

REAR VIEW