



PRODUCT FEATURES

- Open front
- Stainless steel hinged rear door
- Deck forced refrigeration
- Double glazed glass ends
- Two adjustable glass shelves
- Ticket strips on shelves and base
- Under shelf and canopy LED lights
- Pull down night blind
-

CABINET DIMENSIONS & SPECIFICATIONS

Refrigerated 4⁰ factory set point

| Model | Cabinet | | | Shelving no. | SHELVES SIZE | | | | Total food units | Display m2 |
|--------|-----------|----------|-----------|--------------|--------------|---------|-----|-----------|------------------|------------|
| | Length mm | Depth mm | Height mm | | TOP | 2ND | 3RD | BASE(WXD) | | |
| BTGOR6 | 600 | 750 | 1380 | 2+BASE | 490X290 | 490X380 | NA | 545X515 | 55 | |

Prior to installation see, installation guidelines, ventilation requirements and drainage options documents

| Refrigerant | Operating Current | Connection | Voltage |
|-------------|-------------------|------------------|---------------------|
| R134A | 3.3 Amp | 10amp 3 pin plug | 50/60 Hertz 240V |

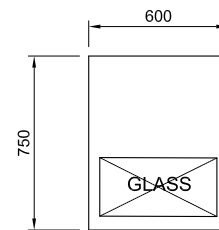

ELECTRICAL POWER

Electrical power cord 2200mm
3 pin 10 amp 1 phase socket required
Maximum ambient operating temperature 25°C @ RH 55

Maximum shelf load weight 15kg
spread evenly

All units rear venting

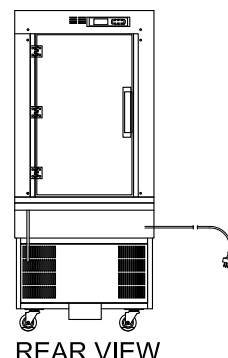
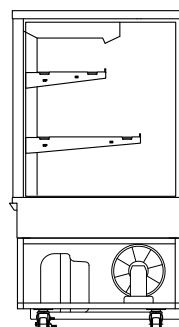
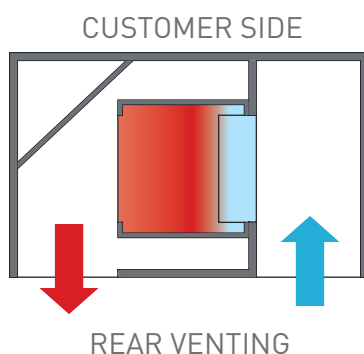
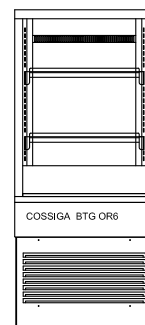
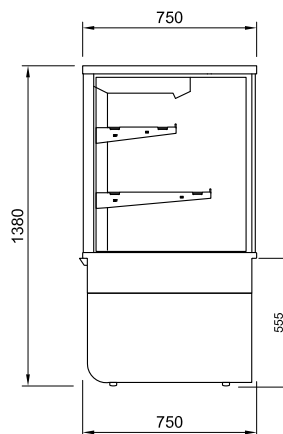



PRODUCT FEATURES

- Open front
- Stainless steel hinged rear doors
- Deck forced refrigeration
- Double glazed glass ends
- Two adjustable glass shelves
- Ticket strips on shelves and base
- Under shelf and canopy LED lights
- Pull down night blind
- Integral condenser

CABINET DIMENSIONS & SPECIFICATIONS

Refrigerated 4⁰ factory set point

| Model | Cabinet | | | Shelving no. | SHELVES SIZE | | | | Total food units | Display m2 |
|--------|-----------|----------|-----------|--------------|--------------|---------|-----|-----------|------------------|------------|
| | Length mm | Depth mm | Height mm | | TOP | 2ND | 3RD | BASE(WXD) | | |
| BTGOR9 | 900 | 750 | 1380 | 2+BASE | 790X290 | 790X380 | NA | 845X515 | 114 | |

Prior to installation see, installation guidelines, ventilation requirements and drainage options documents

| Refrigerant | Operating Current | Connection | Voltage |
|-------------|-------------------|------------------|---------------------|
| R134A | 3.7 Amp | 10amp 3 pin plug | 50/60 Hertz 240V |

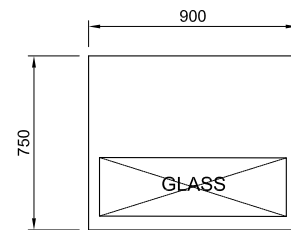

ELECTRICAL POWER

Electrical power cord 2200mm
3 pin 10 amp 1 phase socket required
Maximum ambient operating temperature 25°C @ RH 55

Maximum shelf load weight 15kg spread evenly

All units rear venting

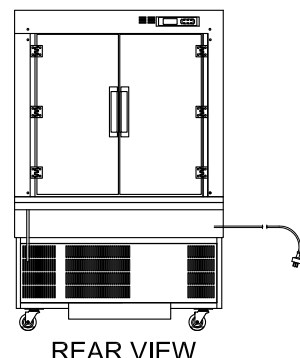
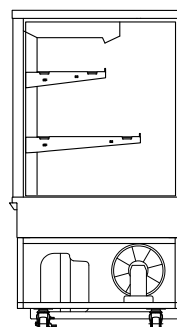
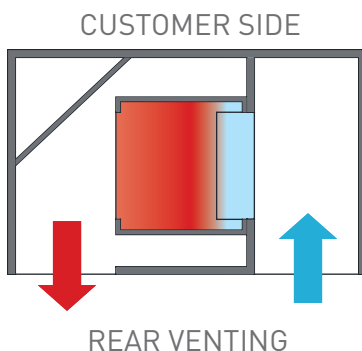
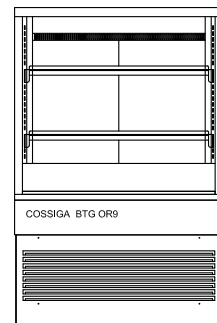
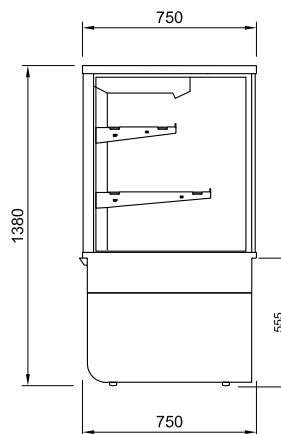



PRODUCT FEATURES

- Open front
- Stainless steel hinged rear doors
- Deck forced refrigeration
- Double glazed glass ends
- Two adjustable glass shelves
- Ticket strips on shelves and base
- Under shelf and canopy LED lights
- Pull down night blind
- Integral condenser

CABINET DIMENSIONS & SPECIFICATIONS

Refrigerated 4⁰ factory set point

| Model | Cabinet | | | Shelving no. | SHELVES SIZE | | | | Total food units | Display m2 |
|---------|-----------|----------|-----------|--------------|--------------|------------|-----|------------|------------------|------------|
| | Length mm | Depth mm | Height mm | | TOP | 2ND | 3RD | BASE(WXD) | | |
| BTGOR12 | 1200 | 750 | 1380 | 2+BASE | 1090 X 290 | 1090 X 380 | NA | 1145 X 515 | 123 | |

Prior to installation see, installation guidelines, ventilation requirements and drainage options documents

| Refrigerant | Operating Current | Connection | Voltage |
|-------------|-------------------|------------------|---------------------|
| R134A | 5.4 Amp | 10amp 3 pin plug | 50/60 Hertz 240V |

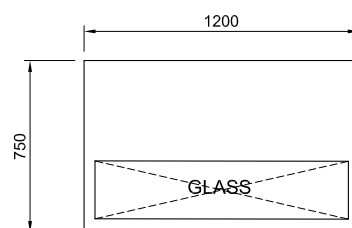

ELECTRICAL POWER

Electrical power cord 2200mm
3 pin 10 amp 1 phase socket required
Maximum ambient operating temperature 25°C @ RH 55

Maximum shelf load weight 15kg
spread evenly

All units rear venting

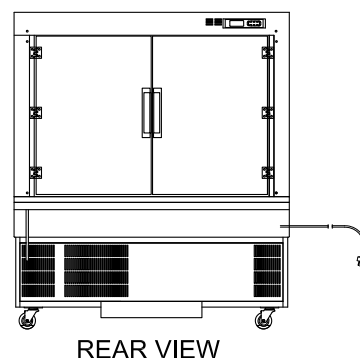
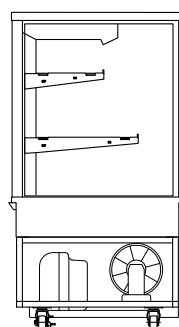
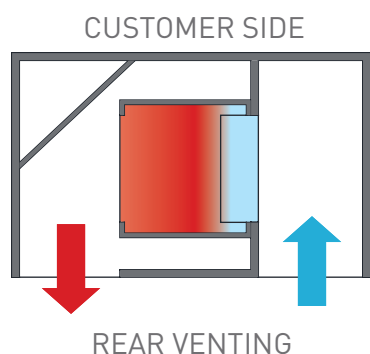
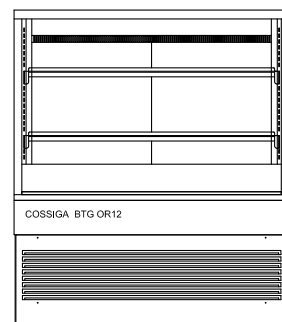
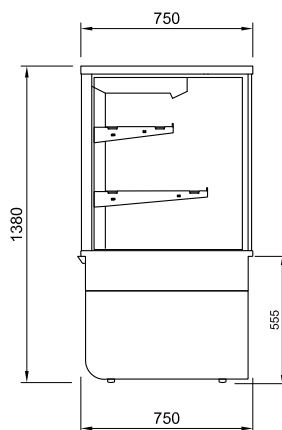



PRODUCT FEATURES

- Open front
- Stainless steel hinged rear doors
- Deck forced refrigeration
- Double glazed glass ends
- Two adjustable glass shelves
- Ticket strips on shelves and base
- Under shelf and canopy LED lights
- Pull down night blind
- Integral condenser

CABINET DIMENSIONS & SPECIFICATIONS

Refrigerated 4⁰ factory set point

| Model | Cabinet | | | Shelving no. | SHELVES SIZE | | | | Total food units | Display m2 |
|---------|-----------|----------|-----------|--------------|--------------|----------|-----|------------|------------------|------------|
| | Length mm | Depth mm | Height mm | | TOP | 2ND | 3RD | BASE(WXD) | | |
| BTGOR15 | 1500 | 750 | 1380 | 2+BASE | 1390X290 | 1390X380 | NA | 1445 X 515 | 168 | |

Prior to installation see, installation guidelines, ventilation requirements and drainage options documents

| Refrigerant | Operating Current | Connection | Voltage |
|-------------|-------------------|------------------|---------------------|
| R134A | 6.5 Amp | 10amp 3 pin plug | 50/60 Hertz 240V |

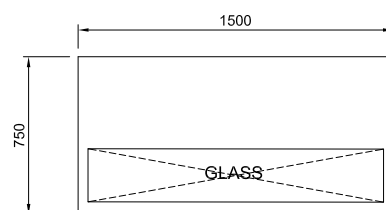

ELECTRICAL POWER

Electrical power cord 2200mm
3 pin 10 amp 1 phase socket required
Maximum ambient operating temperature 25°C @ RH 55

Maximum shelf load weight 15kg
spread evenly

All units rear venting

