



PRODUCT FEATURES

- Auto fill
- Wet elements
- Overhead halogen lights
- 65mm deep full size pans supplied
- Glass supplied separately *

UNIT DIMENSIONS & SPECIFICATIONS

BAIN MARIE 75⁰ factory set point

Model	Cabinet			bench cut out hole size	Pans	water fill litres	Operating Current	Connection	Voltage
	Length mm	Depth mm	Height mm						
LSBM3	1145	690	555	1125x670	3 x 1/1 65mm Gastro Pans	57	15 Amp	20 amp lead only	240V 50/60 Hertz

* prior to installation see, installation guidelines, ventilation requirements and drainage options documents

* GLASS AND GANTRY OPTIONS

When ordering a LS unit select the gantry glass type you require from the [GLASS OPTIONS](#) page in this document.

ELECTRICAL POWER

Electrical power cord 3000mm
1 phase connection required.

Unit can be hard wired to isolation switch or fitted with suitable heavy duty plug such as PDL 56 series or Commando style plug.

WATER DRAINAGE

Screw on stop cock valve drain pipe
Ideally drain connected to waste.
Overflow flexible waste pipe 20mm dia.1000 mm length from valve must be connected to waste.

GASTRO PANS

Units supplied with 1/1 pans at 65mm deep, max pan depth is 100mm

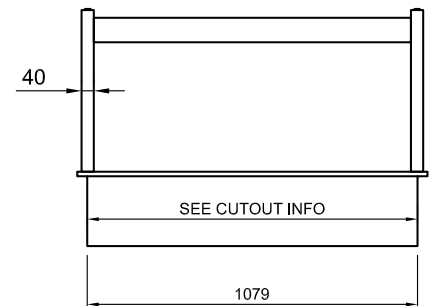
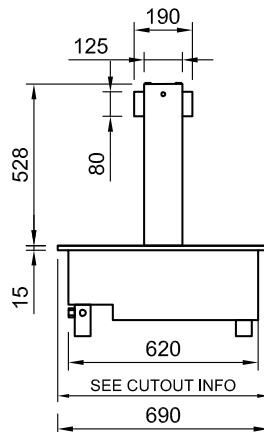
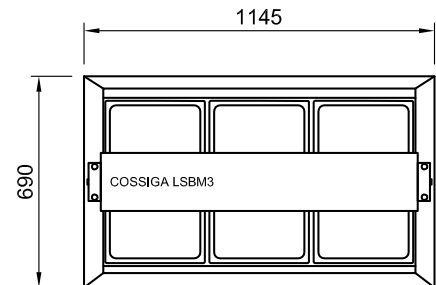



PRODUCT FEATURES

- Auto fill
- Wet elements
- Overhead halogen lights
- 65mm deep full size pans supplied
- Glass supplied separately *

UNIT DIMENSIONS & SPECIFICATIONS

BAIN MARIE 75⁰ factory set point

Model	Cabinet			bench cut out hole size	Pans	water fill litres	Operating Current	Connection	Voltage
	Length mm	Depth mm	Height mm						
LSBM4	1485	690	555	1465x670	4 x 1/1 65mm Gastro Pans	75	20 Amp	30 amp lead only	240V

* prior to installation see, installation guidelines, ventillation requirements and drainage options documents

* GLASS AND GANTRY OPTIONS

When ordering a LS unit select the gantry glass type you require from the [GLASS OPTIONS](#) page in this document.

ELECTRICAL POWER

Electrical power cord 3000mm
1 phase connection required.

Unit can be hard wired to isolation switch or fitted with suitable heavy duty plug such as PDL 56 series or Commando style plug.

WATER DRAINAGE

Screw on stop cock valve drain pipe
Ideally drain connected to waste.
Overflow flexible waste pipe 20mm dia.1000 mm length from valve must be connected to waste.

GASTRO PANS

Units supplied with 1/1 pans at 65mm deep, max pan depth is 100mm

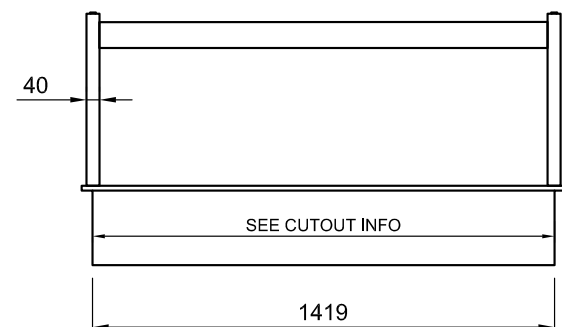
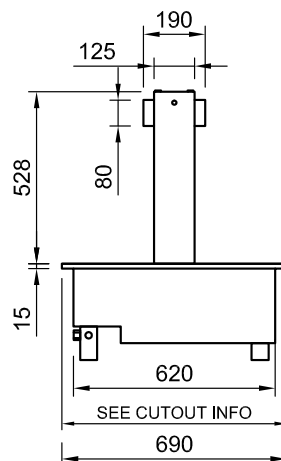
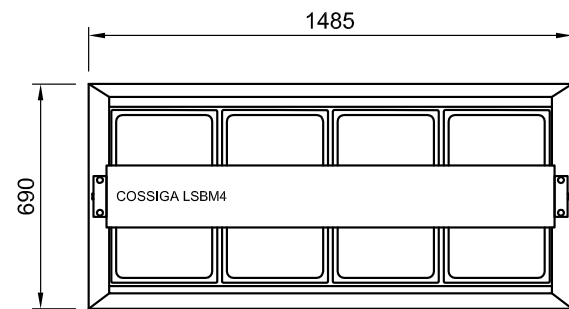



PRODUCT FEATURES

- Auto fill
- Wet elements
- Overhead halogen lights
- 65mm deep full size pans supplied
- Glass supplied separately *

UNIT DIMENSIONS & SPECIFICATIONS

BAIN MARIE 75⁰ factory set point

Model	Cabinet			bench cut out hole size	Pans	water fill litres	Operating Current	Connection	Voltage
	Length mm	Depth mm	Height mm						
LSBM5	1825	690	555	1805x670	5 x 1/1 65mm Gastro Pans	93	25 Amp	30 amp lead only	240V

* prior to installation see, installation guidelines, ventillation requirements and drainage options documents

* GLASS AND GANTRY OPTIONS

When ordering a LS unit select the gantry glass type you require from the [GLASS OPTIONS](#) page in this document.

ELECTRICAL POWER

Electrical power cord 3000mm
1 phase connection required.

Unit can be hard wired to isolation switch or fitted with suitable heavy duty plug such as PDL 56 series or Commando style plug.

WATER DRAINAGE

Screw on stop cock valve drain pipe
Ideally drain connected to waste.
Overflow flexible waste pipe 20mm dia.1000 mm length from valve must be connected to waste.

GASTRO PANS

Units supplied with 1/1 pans at 65mm deep, max pan depth is 100mm

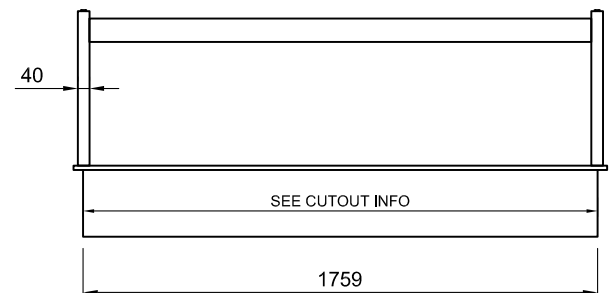
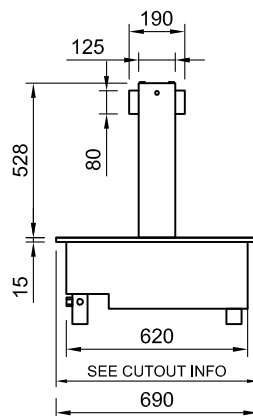
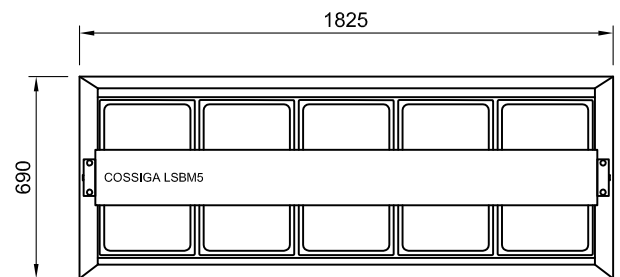



PRODUCT FEATURES

- Auto fill
- Wet elements
- Overhead halogen lights
- 65mm deep full size pans supplied
- Glass supplied separately *

UNIT DIMENSIONS & SPECIFICATIONS

BAIN MARIE 75⁰ factory set point

Model	Cabinet			bench cut out hole size	Pans	water fill litres	Operating Current	Connection	Voltage
	Length mm	Depth mm	Height mm						
LSBM6	2165	690	555	2145x670	6 x 1/1 65mm Gastro Pans	113	30 Amp	40 amp lead only	240V 50/60 Hertz

* prior to installation see, installation guidelines, ventilation requirements and drainage options documents

* GLASS AND GANTRY OPTIONS

When ordering a LS unit select the gantry glass type you require from the [GLASS OPTIONS](#) page in this document.

ELECTRICAL POWER

Electrical power cord 3000mm
1 phase connection required.

Unit can be hard wired to isolation switch or fitted with suitable heavy duty plug such as PDL 56 series or Commando style plug.

WATER DRAINAGE

Screw on stop cock valve drain pipe
Ideally drain connected to waste.
Overflow flexible waste pipe 20mm dia.1000 mm length from valve must be connected to waste.

GASTRO PANS

Units supplied with 1/1 pans at 65mm deep, max pan depth is 100mm

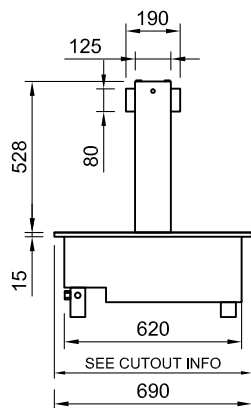
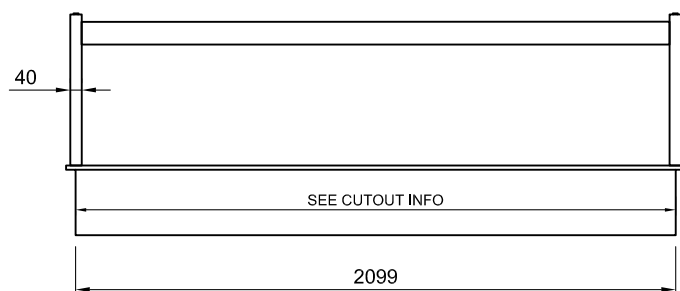
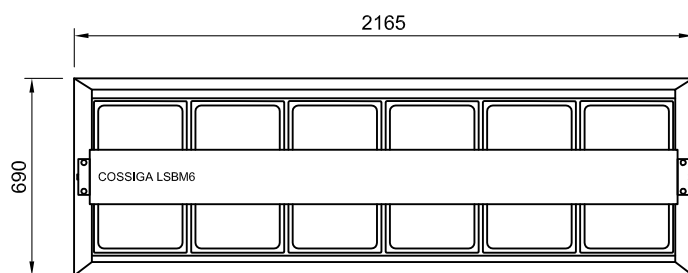



DOUBLE CURVED GLASS

- Clear 8mm toughend glass
- Curved two sides

DIMENSIONS & SPECIFICATIONS

Model	glass size			Part Number
	Length X mm	Depth mm	Height mm	
GLDC GLASS TYPE				
LSCM2	795	685	96	S21-634
LSRF3/LSBM3/LSCM3	1135	685	96	S21-596
LSRF4/LSBM4/LSCM4	1475	685	96	S21-635
LSRF5/LSBM5/LSCM5	1815	685	96	S21-636
LSRF6/LSBM6/LSCM6	2155	685	96	S21-637

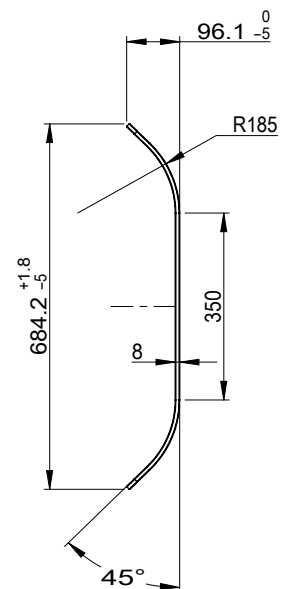
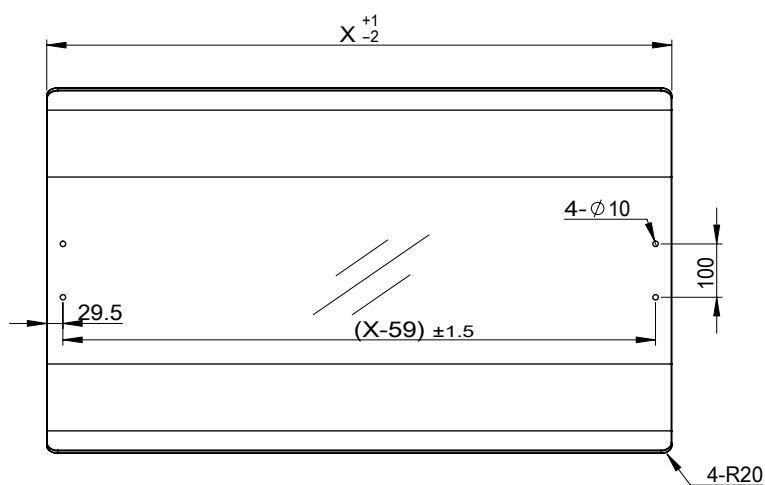



FLAT TOP GLASS

- Clear 8mm toughend glass
- Flat top and sides

DIMENSIONS & SPECIFICATIONS

Model	glass size			Part Number
	Length X mm	Depth mm	Height mm	
GLFT GLASS TYPE				
LSCM2	795	685	100	S21-626
LSRF3/LSBM3/LSCM3	1135	685	100	S21-583
LSRF4/LSBM4/LSCM4	1475	685	100	S21-627
LSRF5/LSBM5/LSCM5	1815	685	100	S21-628
LSRF6/LSBM6/LSCM6	2155	685	100	S21-629

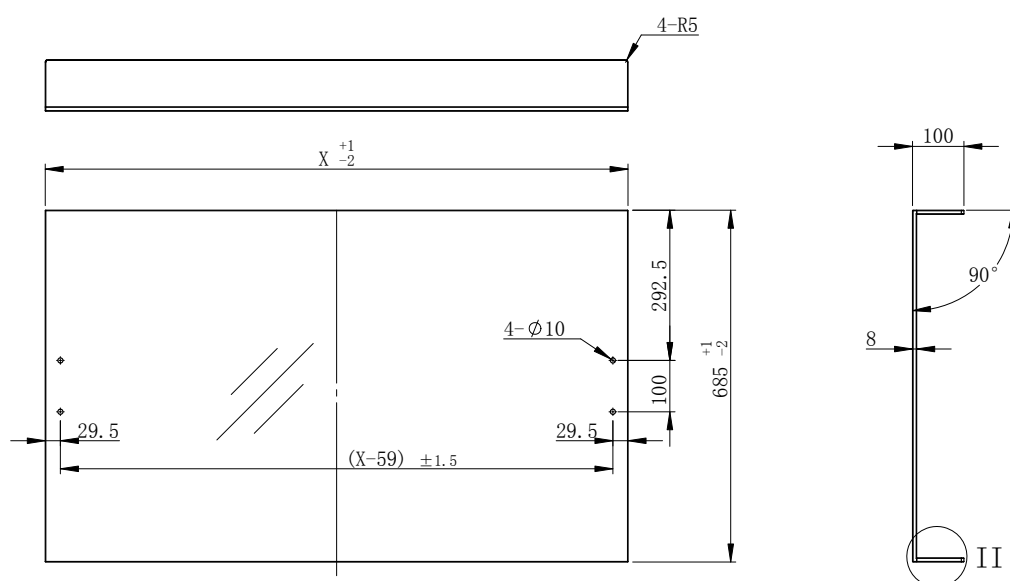



FULL CURVED GLASS

- Sliding acrylic rear doors
- Glass sides
- Clear 8mm toughend glass
- Full curve on front

DIMENSIONS & SPECIFICATIONS

Model	glass size			Part Number
GLFC GLASS TYPE	Length X mm	Depth mm	Height mm	
LSCM2	795	690	540	
LSRF3/LSBM3/LSCM3	1135	690	540	
LSRF4/LSBM4/LSCM4	1475	690	540	
LSRF5/LSBM5/LSCM5	1815	690	540	
LSRF6/LSBM6/LSCM6	2155	690	540	

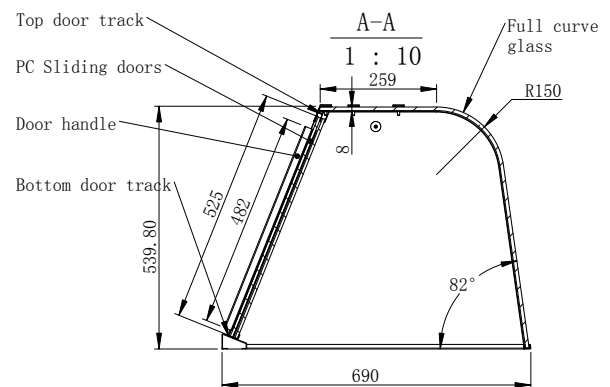
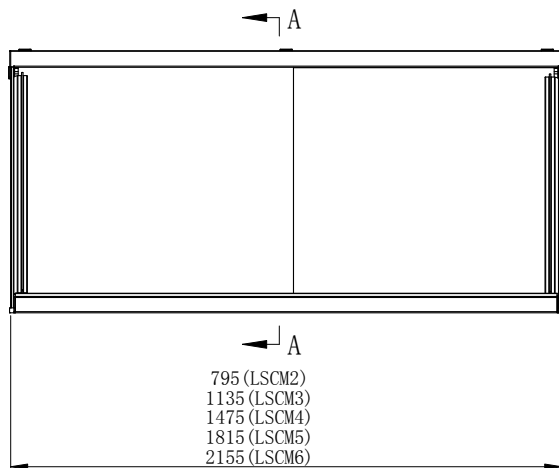



FULL SQUARE GLASS

- Sliding acrylic rear doors
- Glass sides
- Clear 8mm toughend glass

DIMENSIONS & SPECIFICATIONS

Model	glass size			Part Number
	Length X mm	Depth mm	Height mm	
GLFSG GLASS TYPE				
LSCM2	795	690	540	
LSRF3/LSBM3/LSCM3	1135	690	540	
LSRF4/LSBM4/LSCM4	1475	690	540	
LSRF5/LSBM5/LSCM5	1815	690	540	
LSRF6/LSBM6/LSCM6	2155	690	540	

